

# EU Type Examination Certificate

**No. 0200-MID-09552**

**WBC-H**

**AUTOMATIC CATCHWEIGHING INSTRUMENT**

**Issued by**        **FORCE Certification**  
EU - Notified Body No. 0200

In accordance with the requirements in Directive 2014/32/EU of the European Parliament and Council.

**Issued to**        **BEUMER Group A/S**  
P. O. Pedersen Vej 10  
8200 Aarhus N  
Denmark

**In respect of**    Automatic catch weighing instrument designated WBC-H for dynamic or static weighing with variants of peripheral equipment.  
Accuracy class Y(a).  
Maximum capacity, Max:  $\leq 50$  kg.  
Verification scale interval:  $e_1 \geq 10$  g  
Maximum number of verification scale intervals per interval:  $n = 5000$   
Variants of modules and conditions for the composition of the modules are set out in the annex.

The conformity with the essential requirements in Annex 1 and the specific requirements in Annex VIII (MI-006), chapter I & II of the Directive 2014/32/EU is met by the application of OIML R51-1:2006, WELMEC Guide 8.16-1:2013, and WELMEC Guide 7.2:2015.

**Note: This certificate is a revision of DK0199.242 Rev. 5 extending the validation period.**

The principal characteristics and approval conditions are set out in the descriptive annex to this certificate.

The annex comprises 15 pages.

**Issued on**        **2021-02-09**  
**Valid until**     **2031-02-09**

FORCE Certification references:

Task no.: 120-34803.90.10 and ID no.: 0200-MID-09552

**Signatory: Jens Hovgård Jensen**

## Descriptive annex

<b>Contents</b>		<b>Page</b>
<b>1.</b>	<b>Name and type of instrument and modules</b>	<b>2</b>
<b>2.</b>	<b>Description of the construction and function</b>	<b>2</b>
2.1	Construction	2
2.2	Functions	3
2.3	Options	7
<b>3.</b>	<b>Technical data</b>	<b>8</b>
3.1	WBC-H Automatic catchweighing instrument	8
3.2	Load cells	8
3.3	Load receptors	9
3.4	Documents	9
<b>4.</b>	<b>Interfaces and peripheral equipment</b>	<b>9</b>
4.1	Interfaces	9
4.2	Peripheral equipment	9
<b>5.</b>	<b>Approval conditions</b>	<b>10</b>
5.1	Connection of cables	10
5.2	Alibi system	10
<b>6.</b>	<b>Special conditions for verification</b>	<b>10</b>
<b>7.</b>	<b>Securing and location of seals and verification marks</b>	<b>11</b>
7.1	Securing and sealing	11
7.2	Identification plate	11
<b>8.</b>	<b>Location of CE mark of conformity and inscriptions</b>	<b>11</b>
8.1	Identification plate	11
<b>9.</b>	<b>Pictures</b>	<b>13</b>

## 1. Name and type of instrument and modules

The instrument is an automatic weighing instrument, designated WBC-H (Weighing Belt Conveyor), for dynamic or static weighing and consisting of a Display unit (see below), mounted in a steel enclosure and a load receptor equipped with 4 digital load cells.

The Display unit consists of a Weighing Controller board (4025), a load cell connection board (4014) and a User terminal (4024L).

Each load cell communicates with the Weighing Controller through the load cell connection board using RS485.

The instrument is a 24 Vdc powered, self-indicating weighing instrument with single-interval or multi-interval.

The separate units that the weighing instrument is composed of are listed in section 2.1.

The modules appear from the sections 3.1, 3.2 and 3.3.

Note: Components or complete instrument may be branded as Beumer or Crisplant (Crisplant A/S is a member of the Beumer Group).

## 2. Description of the construction and function

### 2.1 Construction

#### 2.1.1 Display unit 4024L

The Display module comprises of,

- A Primary Weight display: six (6) digits, seven (7) segment LED`s
- A Secondary Data and Parameter display: six (6) digits, seven (7) segment LED`s
- Weighing unit annunciator, “kg”
- Status annunciators for WN (weigh now), AZ (auto zero) and >0< (zero)
- Status annunciators for 3 digital inputs and 3 digital outputs
- Status annunciators for scale modes (F1-F5)
- Keypad and keys for >0< and AT functions

#### 2.1.2 Weighing controller 4025 with load cell connection board 4014 as piggyback

The weighing controller is a microprocessor controlled PCB, which performs all the controls of the automating weighing instrument and all the data processing using the weight values received from the individual load cell through the load cell interface board.

#### 2.1.3 Load cells

Set out in Section 3.2.

#### 2.1.4 Load receptor

Set out in Section 3.3.

#### 2.1.5 Interfaces and peripheral equipment

Set out in Section 4.

## 2.2 Functions

The instrument is a microprocessor based electronic instrument for connection to load receptor with digital load cells having RS485 output utilising Eilersen Electric load cell protocol.

The software is downloaded in EEPROM.

The functions provided are detailed below.

### 2.2.1 Power up

During power up, the Display module first displays the number 8 on all seven-segment displays and all annunciators are illuminated for two seconds, then the software version and its date (YYMMDD) will be displayed followed by display of the event counter.

If the weighing instrument is configured with a warm-up time it will now wait for this specified time, while counting it down on the display.

Next, after initial zero setting, the Primary Weight display will continuously show actual load<sup>1)</sup>, and in the secondary display “ready” is displayed.

<sup>1)</sup> When a parcel is detected, the display will be blanked, and when the parcel is weighed, the weight will be displayed for 2 seconds unless the weighing of the next parcel is finished before that.

### 2.2.2 Zero setting

The initial zero setting range is  $\pm 10\%$  of Maximum capacity.

The zero setting range is  $\pm 2\%$  of Maximum capacity.

The annunciator besides the AT-key illuminates, when the no-load measurement is within  $\pm 0.25 e_1$  of the zero point.

#### 2.2.2.1 Zero tracking

The weighing instrument has an automatic zero tracking device. This will allow the instrument to check and track the zero, when the weighing belt is empty. When the weight signal is zero (within  $\pm 0.5 \times e_1$ ), zero tracking will operate in order to maintain the instrument at zero within  $\pm 0.25 \times e_1$ . When the no-load weighing signal is not zero (exceeds  $\pm 0.5 \times e_1$ ), error code 56/57 "Unable to zero" is displayed as well as added to the transmitted record with weighing result for the next parcel that is weighed.

If a number of parcels in a row having an error code exceeded a limit, the CMC (Crisplant Machine Controller), which can control the flow of parcels over the belts, ensures that the weighing belt runs empty and sends a semi-automatic zero-setting command to the weighing instrument.

If the zero setting fails, the weighing belt is stopped, and an alarm is sent to the CSC (Crisplant System Controller).

#### 2.2.2.2 Automatic zero setting

If the maximum time between automatic zero setting has elapsed since the last zero successful operation of the zero-tracking device, the weighing instrument report this to the CMC. The CMC lets the weighing belt run empty and the weighing instrument is set to zero by a semi-automatic zero setting command from the CMC.

### 2.2.3 Keypad

The keypad has 25 keys with the inscriptions: Mode, Param., Print, Shift, F1 to F5, >0<, AT, +/-, Enter, Del, decimal point and the numerals 0 to 9.

By operating the Shift key 5 extra functions keys, 4 arrow keys, Ins key, Esc key and the Hex - numbers A to F may be obtained for use in a variety of application programs.

The >0<, AT and +/- keys are for the basic weighing functions and the numerical, decimal point and plus-minus keys are for entering data. The rest of the keys have functions, which depend on the actual application program.

### 2.2.4 Photocells

The weighing instrument is fitted with photocell units, which hold one or more photocells. The unit forms a vertical / horizontal light beam, depending on the parcel shape. If one or more photocells are dimmed, the signal status changes.

The weigh-now photocell unit is positioned close to the inlet of the weighing belt and the weight-control photocell unit close to the outlet of the weighing belt or at the inlet of the succeeding belt (both with configurable position).

The photocell signal named, “weigh-now” starts a weighing sequence. The weight-control signal ensures that only one (1) parcel is weighed at a time. Both signals are sent directly to the weighing instrument and at the same time to the control system CMC (Crisplant Machine Controller), which ensures that the photocell unit works correctly.

### 2.2.5 Calibration

The weighing instrument is calibrated both statically and dynamically. First, a static calibration is performed, next a dynamic calibration. In this way, the weighing accuracy for normal automatic operation is optimized.

### 2.2.6 Buffer mode

The weighing instrument can be configured to work as a buffer belt for parcels to be weighed. Normally the parcels will be weighed dynamically, but if the catchweigher receives a ‘sorter blocked’ signal from the CMC then the weighing belt will be stopped with the next parcel on for static weighing of it. The weighing belt will be started again as soon as the static weighing is finished and the ‘sorter blocked’ signal is removed.

This mode is available for all software versions except version CCWD.100501.x.x.x.

### 2.2.7 Dual speed mode

The weighing instrument can be configured to work in a dual speed mode, where the belt speed is decreased, when a long parcel is to be weighed in order to weigh longer parcels than possible with the high speed.

### 2.2.8 Double scale mode

Then two weighing instruments are placed side by side without a barrier between, they shall be configured to work in double scale (DAVI) mode, where a photocell with vertical light beam is placed between the two instruments near the inlet of the weighing belts. A signal from a photocell with a vertical light beam placed in front of and between the two scales weighing belts will normally stop the weighing belt(s) on which the parcel is detected, leaving it to an operator to remove the parcel. If an error occurs and the belt(s) are not stopped by the CMC, error code 76 is displayed in the weighing indicator of the scale(s) as well as added to the transmitted record with weighing result.

When a parcel too big to pass over one weighing instrument is to be handled, the two instruments of the double scale can by the operator be set as master/slave, where they work as a common belt conveyor, but they do not perform any weighing.

### 2.2.9 High resolution of the weight value

Higher resolution can be accessed. This feature is only intended as an aid during evaluation and testing. When high resolution is active, the indicator will not change weighing ranges but uses the same resolution from zero to max.

### 2.2.10 Verification

For each test series, the individual errors of the weighings shall be calculated.

In the CMC (Crisplant Machine Controller), a functional mode is included in which the test items are conveyed forwards and backwards over the weighing section. Weighing and recording are limited to the forward transportation. The function is approved for use when determining the accuracy of the weighing instrument and it supports both dynamic and static weighing mode.

The below procedures are optional:

- (a) Visual reading of the weighing instrument's primary display using the high resolution every time an item is weighed and written down the individual result.  
or
- (b) By connection of a PC to the test plug (RS232) on connector J2 on the 4025 weighing controller. The individual weighing results can be recorded.

See also section 6.

### 2.2.11 Fault detecting

When a weighing result is displayed in the primary weight display, there is a status code displayed on the secondary display.

The status conditions monitored are:

No.	Description of operational errors:	Action
<b>Common for the protocols</b>		
0	No error	
1-23	Reserved	
24-39	Spare	
<b>Priority 1 Errors</b>		
40	Scale is in warm-up condition.	S
41	Not finished with initialization (Init not received or not finished executing init).	S
42-47	Spare	
<b>Priority 2 Errors</b>		
48	No index telegram received before weighing, index 9999 is used in telegram.	
49	Multiple indexes received before detection of an item in the "Weigh_now" photocell. The error code is sent on all received indexes.	S
50	Index already in use. Is send on 1 <sup>st</sup> index, 2 <sup>nd</sup> index is not used (deleted by scale).	S
51	Index telegram error detected. (framing/parity or length/ context).	S
52	Index buffer overflow.	S
53-55	Spare	
<b>Priority 3 Errors</b>		
56	Unable to zero, the gross weight too small.	
57	Unable to zero, the gross weight too large.	
58	Invalid measurement. (Intern over- or under load while measured)	S
59	Out of weighing range	
60	Auto zero necessary.	S
61	Scale belt speed not correct	
62	Spare	
63	Internal scale error.	
<b>Priority 4 Errors</b>		
64	Overweight parcel detected. The parcel is above the maximum weight (range 2)	S
65	Overweight parcel detected. The parcel is above the maximum weight (range 1 = legal range)	
66	Parcel too long.	S
67	More than one parcel on the weighing belt. This error is returned when a parcel cannot be weighed because the distance to the subsequent parcel is too short.	
68	No WEIGH_NOW signal detected. There is no weight value present for this index, because the Scale has not seen a transition of the WEIGH_NOW signal..	
69-71	Spare	

Priority 5 Errors		
72	Weight integration period too short. This error is returned when the calculated weighing time for a parcel is lower than the minimum weighing time set.	
73	Too many parcels detected in PEC. This error is returned when a parcel cannot be weighed because three or more parcels have been seen in the PEC (therefore the middle parcel can not be weighed).	
74	Unknown parcel detected (stray item). This error code indicates that a parcel was not seen in the inlet PEC only in the outlet PEC.	
75	Parcel missing. This error code indicates that a parcel did not arrive at the outlet PEC.	
76	Parcel outside weighing belt. This error code signals that the parcel is not placed correctly on the weighing belt (only for NAVI mode - non-automatic weighing – and DAVI mode – dynamic automatic weighing with two instruments side by side)	S
77	Weight unstable (static weighing only)	
78-79	Spare	
Priority 6 Errors		
80	Underweight parcel detected. The parcel is below the minimum weight.	
81-85	Spare	
86	Scale is in calibration/test mode. Scale has to be in normal mode in order to weigh.	
87	Scale is not sealed	
88-127	Spare	
>128	Are not defined.	

If an error code different from 0 is shown, a valid weighing result cannot be obtained until the faulty condition is removed.

At the error codes marked with Action S the induction incl. the weighing belt is stopped and items are to be removed manually. Other items with an error code different from 0 are inducted onto the sorter and the sorter will normally discharge them at the hospital chute.

In case of a series of similar status codes (default configured to 5 items) different from status code 0, the induction including scale is stopped as well.

### 2.2.12 Software version

Identification of the software version is performed during power-up (see section 2.2.1).

The approved software versions are, CCWD.100501.2.1.x, CCWD.110301.1.1.x, CCWD.110301.1.2.x and CCWD.150616.1.0.x.

## 2.3 Options

### 2.3.1 Alibi system

The WBC-H may be connected to an external alibi system with an Evaluation certificate from a notified body for type examination according to directive 2014/32/EU (MID).

The instrument transmits the legal measuring data to an external alibi system. The transmitted data is protected with a CRC-16 checksum.



### 3. Technical data

The automatic weighing instruments and its modules are set out as follows:

#### 3.1 WBC-H Automatic catchweighing instrument

Type:	WBC-H
Accuracy class:	Y(a)
Weighing mode:	Dynamic or static
Weighing range:	Single-interval or multi-interval (2 or 3 intervals)
Maximum capacity (Max):	≤ 50 kg
Minimum capacity (Min):	≥ 5×e <sub>1</sub>
Verification scale interval (e):	≥ 20 g for software version CCWD.150616.1.0.x, for all other software versions, ≥ 10 g for dynamic weighing ≥ 20 g for static weighing and combined dynamic/static weighing
Number of Verification Scale Intervals (n):	≤ 5000
Maximum tare effect:	≤ 100 % of Max
Temperature range:	-10 °C to 40 °C
Power Supply:	24 Vdc +/- 10%
Electromagnetic class:	E2
Humidity:	Non-condensing
Maximum belt speed:	≤ 2.2 m/s for dynamic weighing ≤ 2.2 m/s for static weighing ≤ 2.2 m/s / 1.2 m/s for dual speed dynamic weighing ≤ 2.2 m/s for buffer mode with dynamic/static weighing
Belt speed:	≤ 2.2 m/sec
Maximum time between auto-zero:	2 minutes for e <sub>1</sub> = 10 g 4 minutes for e <sub>1</sub> = 20 g 10 minutes for e <sub>1</sub> ≥ 50 g
Warm-up time:	≥ 2 minutes for e <sub>1</sub> = 10 g None for e <sub>1</sub> ≥ 20 g
Installation:	Fixed. Longitudinal tilt up to 12° is allowed.

#### 3.2 Load cells

##### 3.2.1 Digital load cell type SPSX

The digital load cell SPSX (see figure 3) is a capacitive measuring cell that is connected to the load cell connection board type 4014, a piggy-back - placed on the weighing controller type 4025 - capable of interfacing to four load cells.

Four SPSX C5 50 kg load cells are used for the WBC-H.

The serial number, software version and software date of each load cell are part of the parameter list of WBC-H.

### 3.3 Load receptors

The weighing belt rests directly on four load cells. Shock absorbers are placed between the load cells and the weighing belt (figure 1).

The load cells are mounted on the chassis of the weighing instrument and positioned under each of the corners of the weighing belt. The chassis incorporates adjustable feet for levelling; however, the instrument is intended for fixed installation (figure 1).

The weighing belt motor is positioned under one (1) of the load cells. The motor is either a standard motor utilizing a remote frequency inverter of various makes or an integrated motor combining the motor and inverter into a single unit (figure 1).

The weighing belt can vary depending on the parcel size of the system, whereas the weighing belt length is dependent upon maximum parcel length and weighing belt speed. However, the design ensures that a minimum weighing time is always obtained.

The weighing belt speed is normally fixed, but the aut. weighing instrument may be configured to have two fixed speed, where the slowest speed is used automatically for long parcels..

The load receptor may be tilted up to 12° longitudinally (see figure 6).

### 3.4 Documents

The documents filed at FORCE (reference No. A530875) are valid for the weighing instruments described here.

## 4. Interfaces and peripheral equipment

### 4.1 Interfaces

These interfaces are declared as “Protective interfaces” by the manufacturer.

#### 4.1.1 Serial interfaces

The Weighing controller is equipped with the following serial interfaces,

- RS422 for communication with an induction controller and further to an external alibi system. A CRC-16 checksum is used, when weight data sent using this interface.
- RS232 used for service and installation purposes.
- RS485 for communication with the display unit (4024L).
- Ethernet (option) to be used for supervision and maintenance.

#### 4.1.2 Digital Input/Output

Used for handshaking with the induction controller.

### 4.2 Peripheral equipment

No peripheral equipment is connected to the WBC-H.

## 5. Approval conditions

### 5.1 Connection of cables

All communication cables shall be shielded, and the shield shall be properly EMC wise connected to the housing / connector in both ends.

### 5.2 Alibi system

As the WBC-H is intended for weighing parcels where one of the transaction parties is absent and since the parcel can not be weighed again in case of a complaint, the WBC-H shall be connected to an externally alibi system with an Evaluation Certificate / Test Certificate issued by a notified body for type examination according to MID.

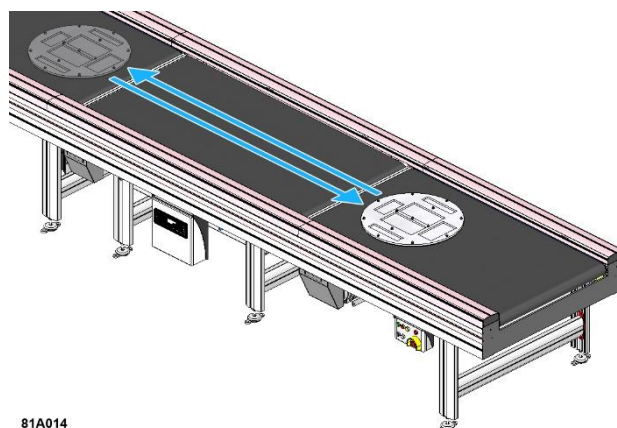
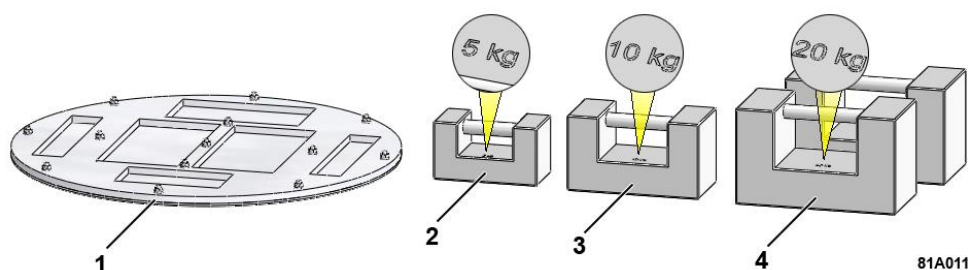
The CSC (Crisplant System Controller) or CSS (Crisplant System Server) incorporates normally an alibi system, which then has to have an Evaluation Certificate in order to be used as an alibi system.

## 6. Special conditions for verification

The software version and checksums of the alibi system shall be checked against the Evaluation Certificate / Part Certificate of the alibi system.

The maximum permissible error at verification is as specified in OIML R51-1:2006, section 2.5.1.2 table 5 for both dynamic and static weighing mode.

The manufacturer can as an option deliver a PVC plate intended for placement of standard weights together with the weighing instrument. The plate can be used to make the tests of the verification officer easier as well as for the self control performed by the instrument owner.



## **7. Securing and location of seals and verification marks**

### **7.1 Securing and sealing**

Seals shall bear the verification mark of a notified body or alternative mark of the manufacturer according to ANNEX II, module F or D of Directive 2014/32/EU.

The value of the event counter of WBC-H shall at verification time be written on the inscription plate or on a brittle plastic sticker, which is then placed on the inscription plate.

In case of a mismatch between the event counter value displayed by WBC-H and the value on the inscription plate the sealing of WBC-H is regarded as broken.

#### **7.1.1 Display module 4024L**

The Display module is purely digital without influence on the weighing result and need as such not to be sealed.

#### **7.1.2 Weighing controller 4025 with load cell connection board 4014 as piggyback**

As the weighing controller contains the event counter of WBC-H, the Weighing controller shall be secured against exchange of the board by a brittle plastic sticker covering one of the mounting screws.

#### **7.1.3 Digital Load Cells SPSX**

The load cells shall be secured against exchange with brittle plastic stickers or their serial numbers shall be written on the inscription plate either directly or on a secured label placed on the plate.

### **7.2 Identification plate**

The identification plate shall be secured against removal with a brittle plastic sticker.

## **8. Location of CE mark of conformity and inscriptions**

### **8.1 Identification plate**

All inscriptions for the instrument shall be placed on the identification plate, which is located on the box in which the display module is mounted.





#### **8.1.1 CE mark**

CE mark and supplementary metrological marking shall be applied to the identification plate according to article 21 of Directive 2014/32/EU.

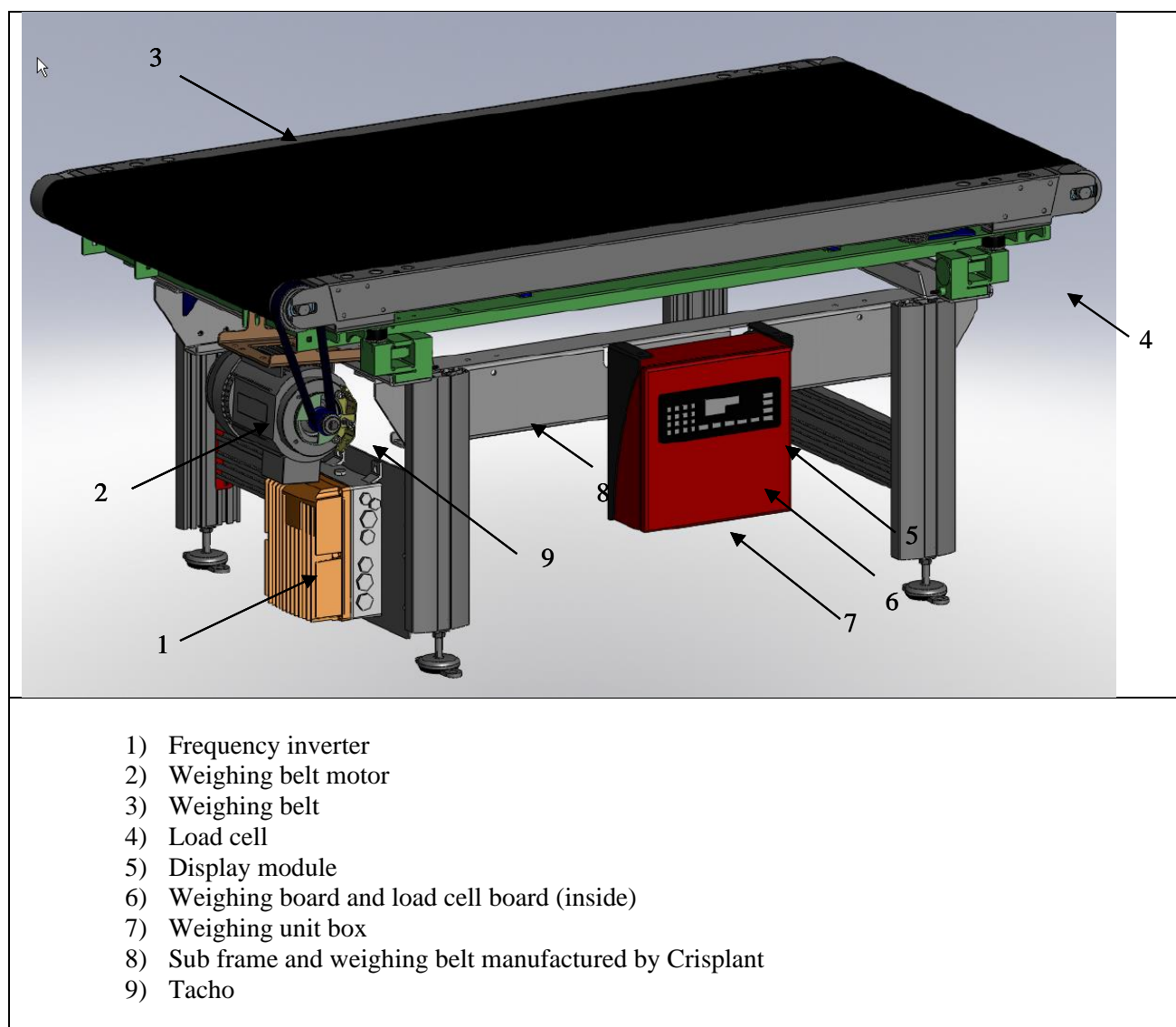
### 8.1.2 Inscriptions

The identification plate shall bear the following inscriptions:

- Manufacturer's trademark and / or name
- Postal address of manufacturer
- Type designation
- Serial number
- Max, Min and e= (these shall additional be duplicated near the display unless the description plate is located near the display)
- Belt conveyer speed
- Temperature range: -10°C / +40°C
- Electromagnetic class: E2
- Humidity: Non-condensing
- Type examination certificate number
- The text: "Approved for: Parcel weighing."

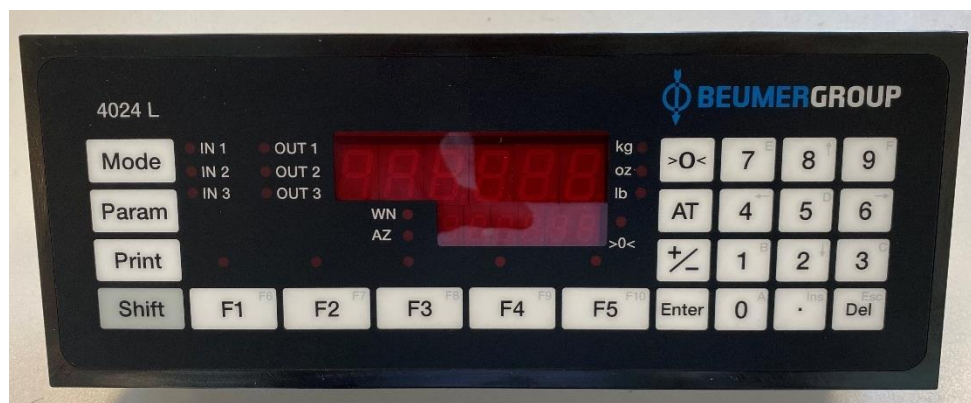
 P.O. Pedersensvej 10 DK-8200 Aarhøus N	Typeapproval	0200-MID-09552	<b>IDENTIFICATION PLATE</b>			
	According to	MID 2014/32 EU	Min. item length	mm Min	g	Temperature -10°C to +40°C
	Accuracy class	Y(a)	Max. item length	mm Max	kg	Humidity Non-condensing
	Approved for	Parcel weighing	e =	g	Conveyor velocity	m/s
	Type/model	WBC-H	Postal scale	5e	Power supply	24 VDC
	Serial no.	xxxxPx	xxxx-xx	Resolution during Test	g	EMC-class E2
			  			

## 9. Pictures

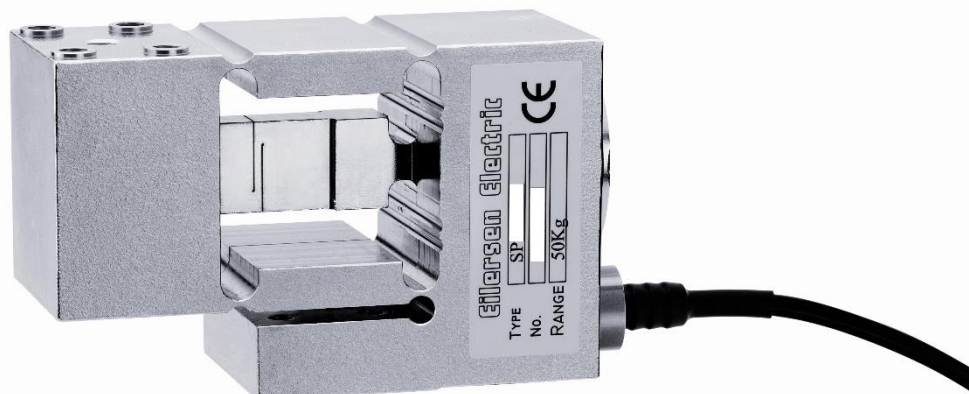


**Figure 1**  
Mechanical Construction

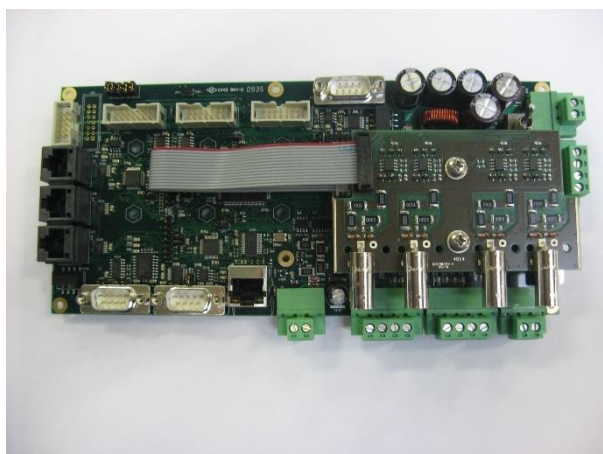




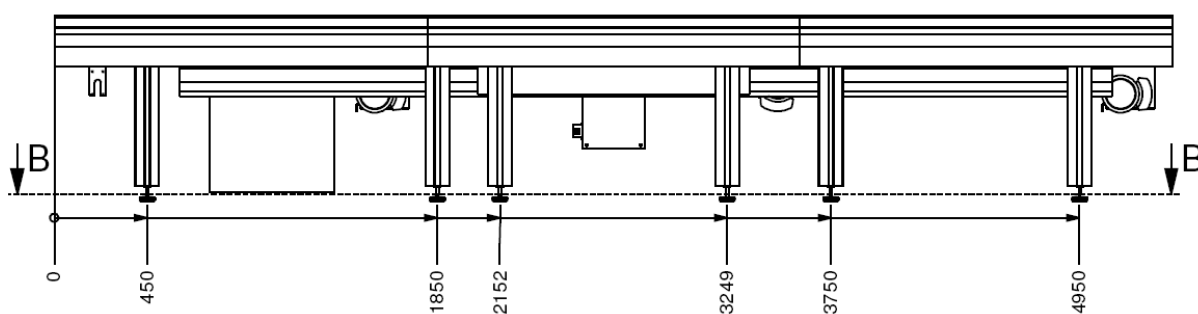
**Figure 2** Samples of user terminal unit, Type 4024L, both logo's accepted



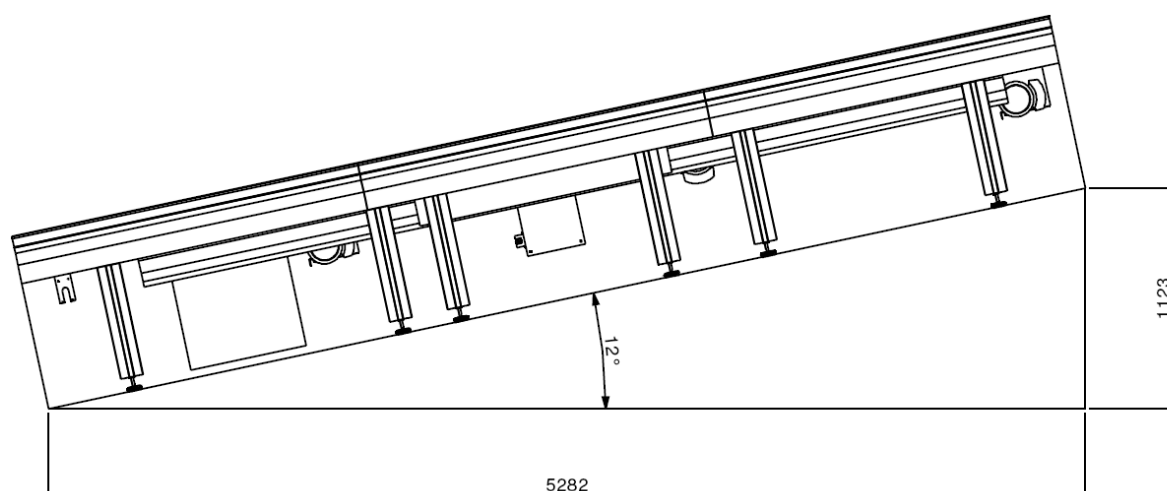
**Figure. 3** Digital Load Cell, Type: SPSX 50 kg



**Figure 4** Weighing board type 4025 with digital load cell interface board type 4014 as piggy-back



**Figure 5** WBC-H with inlet and outlet bands, placed horizontally.



**Figure 6** WBC-H with inlet and outlet bands, placed 12° tilted longitudinally.